

Do Not Scale

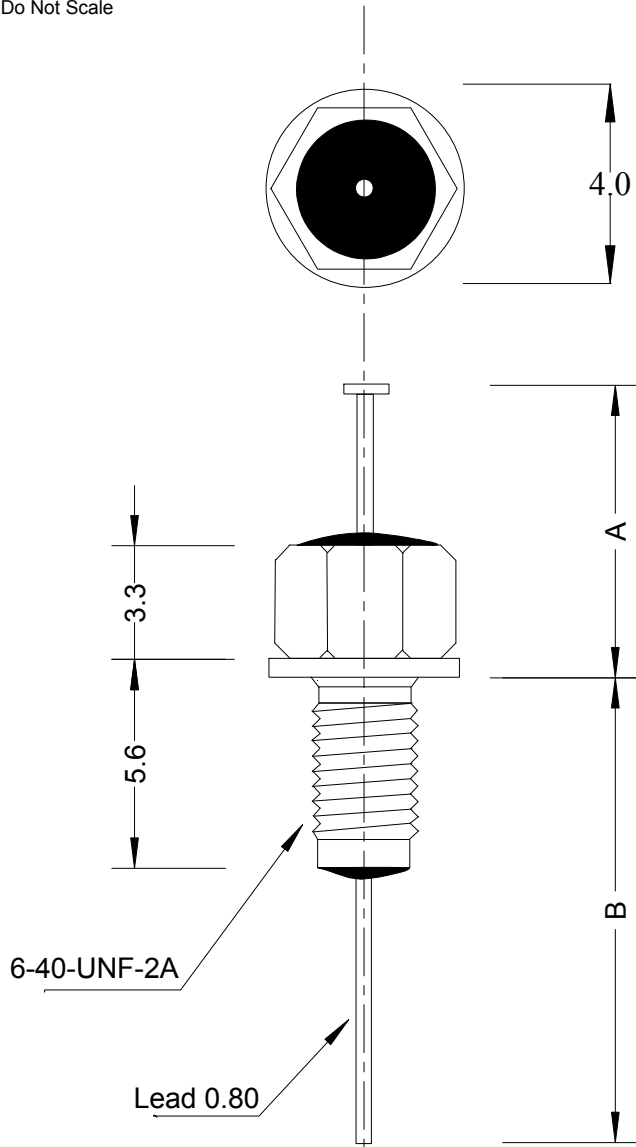
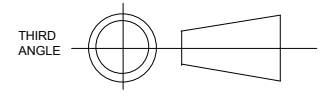

Capacitance Tolerance	min 3000pF
Environmental Classification	55/125/56
Dissipation	<4%
Rated Working Voltage	2000VDC
Withstanding Voltage	1000VDC 1min
Current Rating	10A max
I.R. @ 100VDC	>5Gohm
Operating Temp Range	-55°C to +125°C
Bushing Matl	Ag plated Brass
Lead Matl	Tin plated Cu

Soldering conditions 300°C for 5s max

Recommended installation torque:
 0.4Nm for clearance hole
 0.2Nm for threaded hole

Clearance mounting hole dia 3.6+0.2/-0

Attenuation	
10MHz	8dB
100MHz	50dB
1GHz	70dB
10GHz	70dB

	Tolerance +/-0.75	
	001	002
A	7.5	29
B	24.5	31

Ordering Info

FS-P3000-A--

Blank-no nut or lockwasher
 NT-supplied with nut & lockwasher

001 or 002 (depending on lead length required, see table opposite)

Circuit Diagram

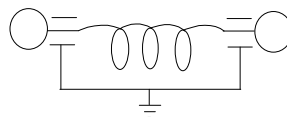

No part of this drawing may be disclosed or copied without written authority of the company

Filtek Solutions Ltd



Filtek Solutions

DRAWN	LR	TITLE	
DATE	28-2-2012	3000pF Feedthrough Pi Filter, 6-40-UNF-2A	
DIMENSION	MM	DRAWING NUMBER	ISSUE
TOLERANCE	One decimal place +/-0.2mm Two decimal places +/-0.05mm	FS-P3000-A	01