

Do Not Scale

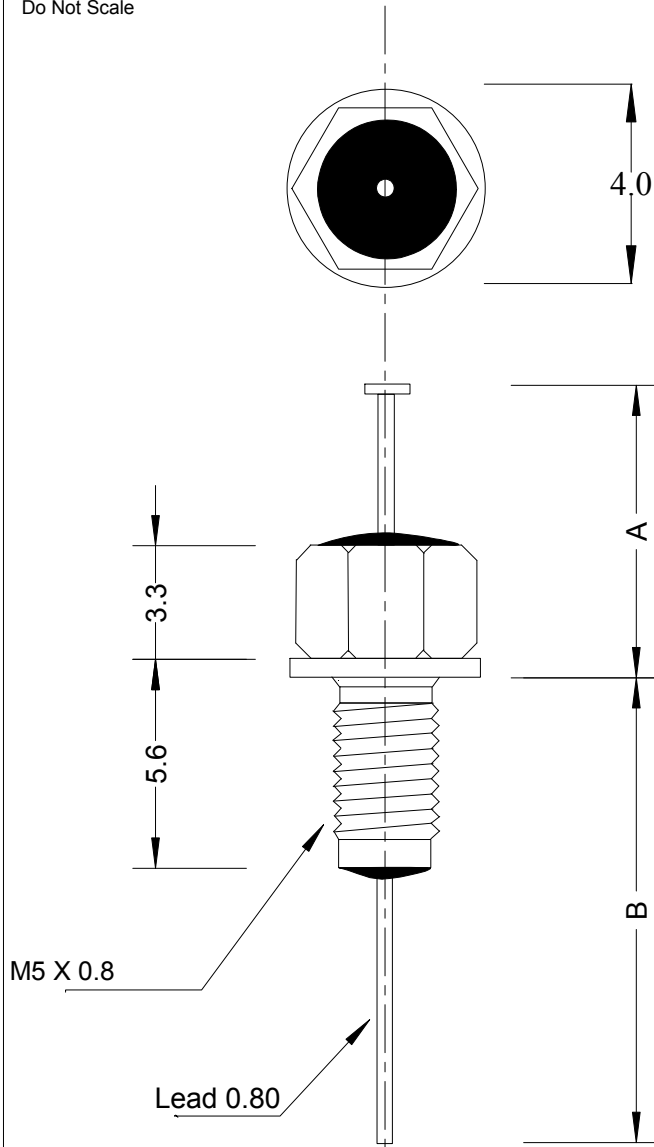
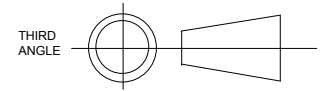

Capacitance Tolerance	min 1500pF
Environmental Classification	55/125/56
Dissipation	<4%
Rated Working Voltage	500VDC
Withstanding Voltage	1500VDC 1min
Current Rating	10A max
I.R. @ 100VDC	>5Gohm
Operating Temp Range	-55°C to +125°C
Bushing Matl	Ag plated Brass
Lead Matl	Tin plated Cu

Attenuation	
10MHz	5dB
100MHz	45dB
1GHz	70dB
10GHz	70dB

Soldering conditions 300°C for 5s max

Recommended installation torque:
 0.8Nm for clearance hole
 0.4Nm for threaded hole

Clearance mounting hole dia 5.1+0.2/-0

Tolerance +/-0.75		
	001	002
A	7.5	29
B	24.5	31

Ordering Info

FS-P1500-M5- -

Blank-no nut or lockwasher
 NT-supplied with nut & lockwasher

001 or 002 (depending on lead length required, see table opposite)

Circuit Diagram

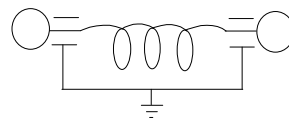

No part of this drawing may be disclosed or copied without written authority of the company

Filtek Solutions Ltd



Filtek Solutions

DRAWN	LR	TITLE	
DATE	26-2-2012	1500pF Feedthrough Pi Filter, M5	
DIMENSION	mm	DRAWING NUMBER	ISSUE
TOLERANCE	One decimal place +/-0.2mm Two decimal places +/-0.05mm	FS-P1500-M5	01